

cut out the following parts only from the "Combi-kit" $\frac{1}{16}$ " printed sheet. A. B. C. D. E. J. L. M. N. O. — and all ribs.

slot for dihedral keeper J.
 fin outline & rib are all $\frac{3}{16}$ " x $\frac{3}{32}$ "

all tailplane outline is $\frac{3}{16}$ " x $\frac{3}{32}$ " with ribs of $\frac{3}{32}$ " x $\frac{3}{32}$ "

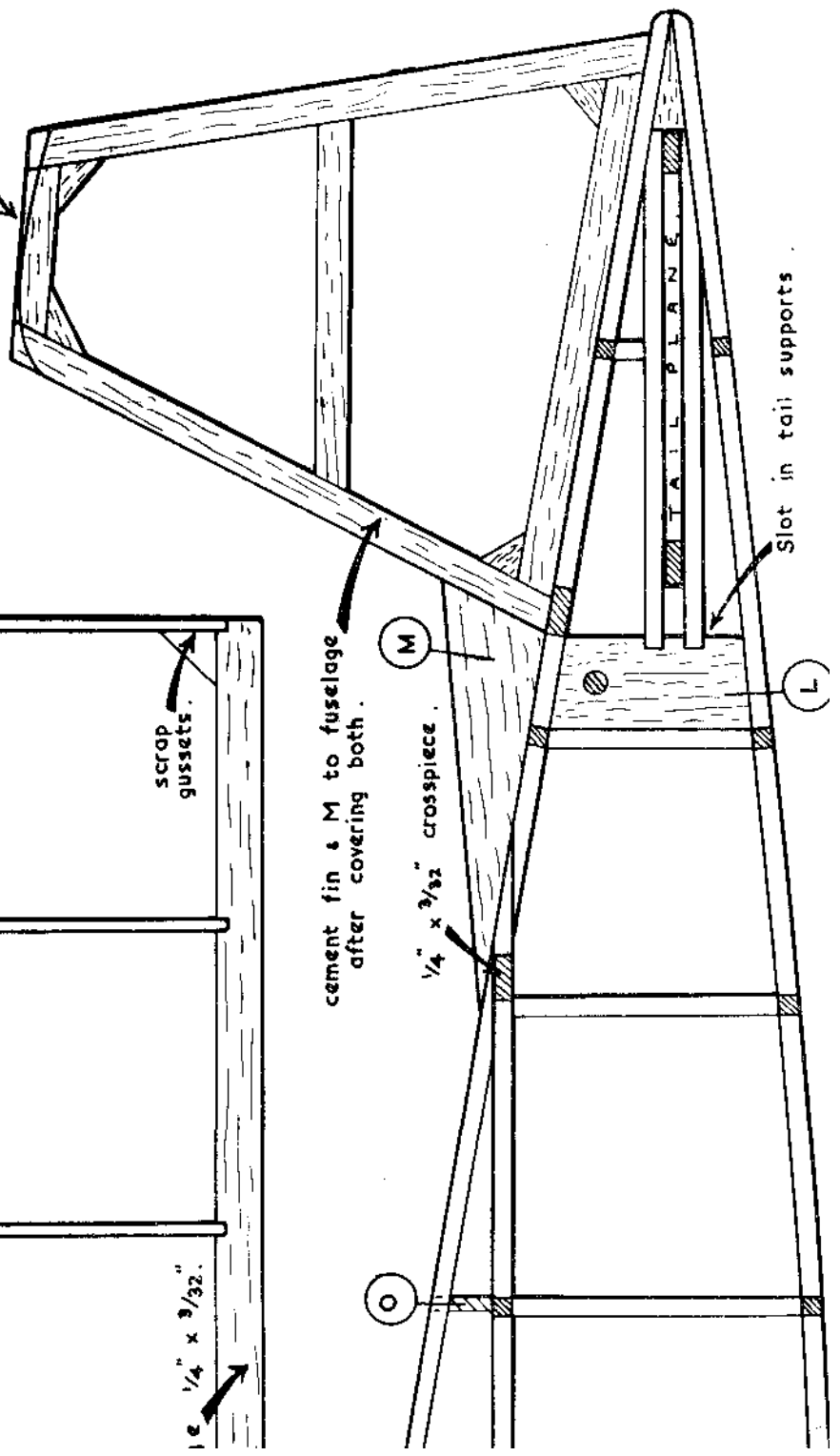

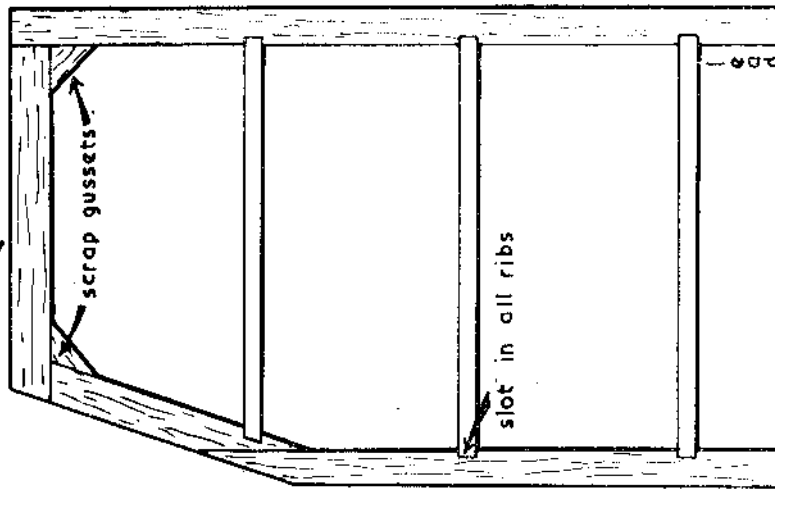
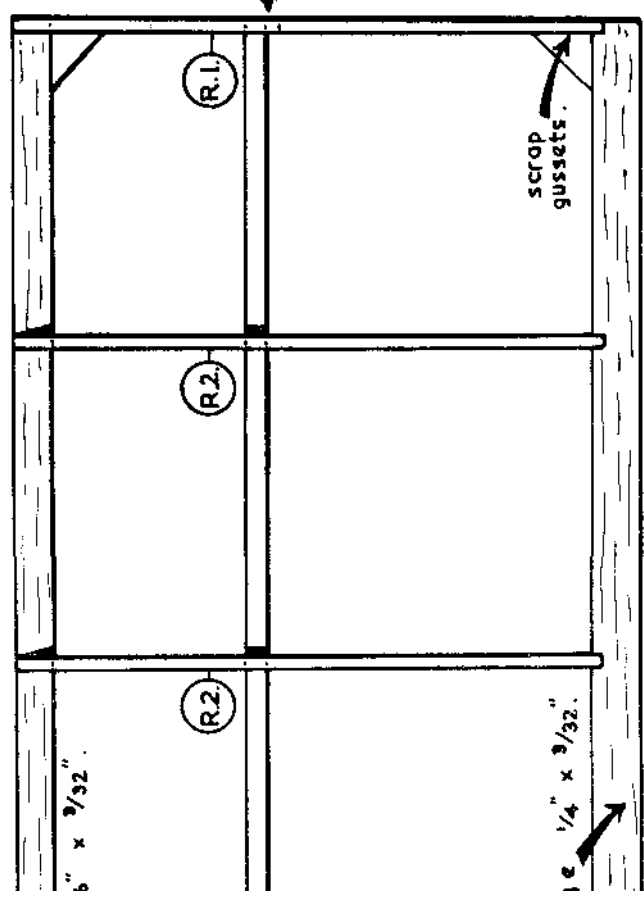
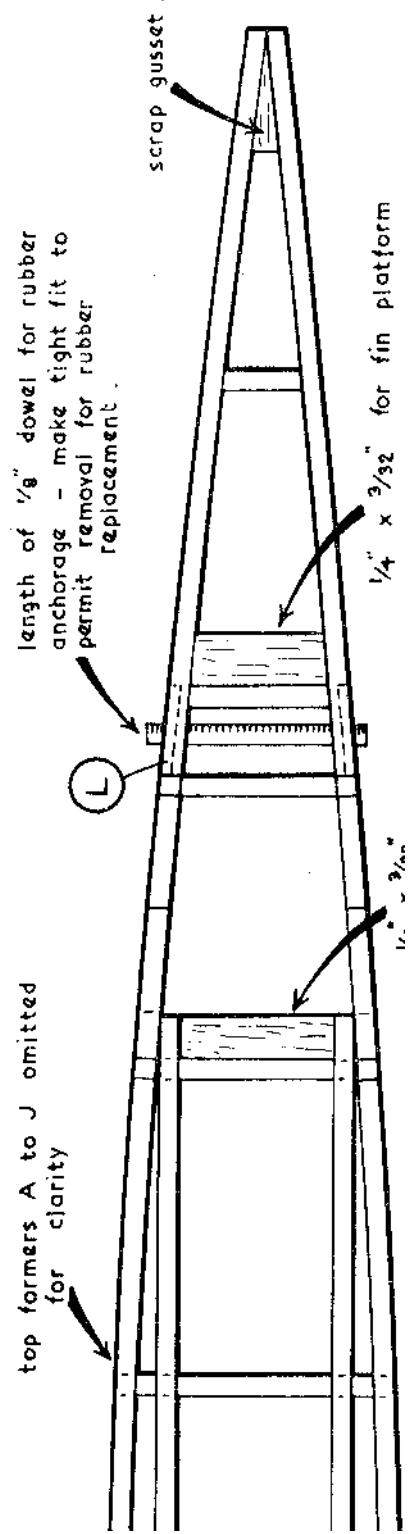
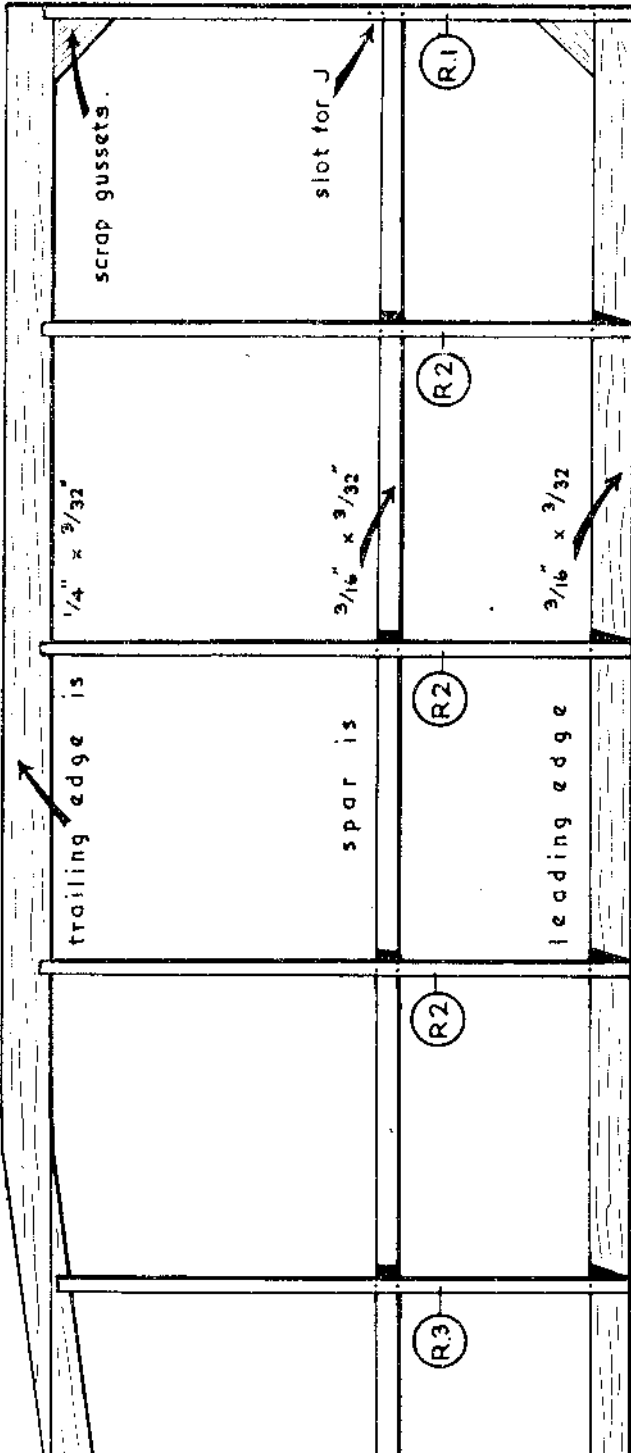
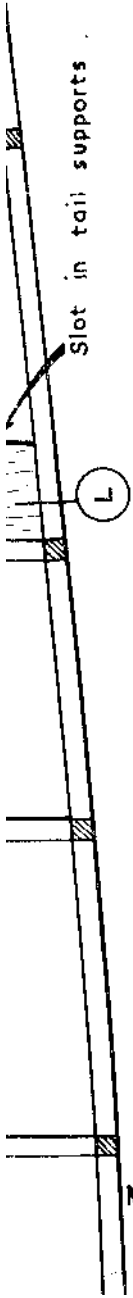
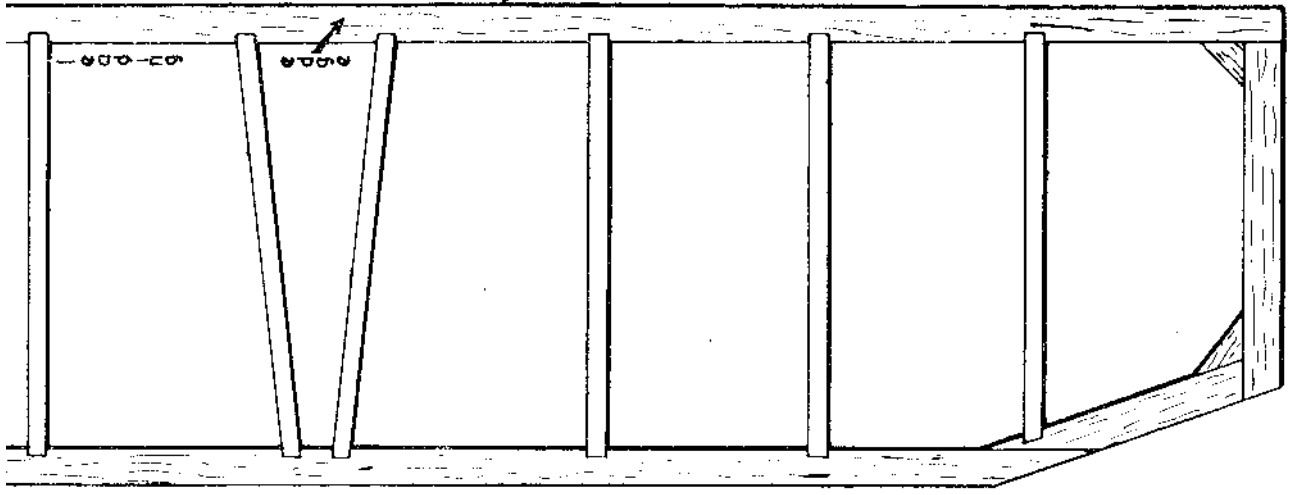

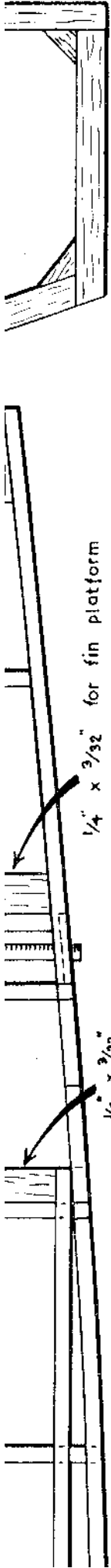

INSUL

20" SPAN LIGHTWEIGHT DURATION MODEL FOR SIMPLE AND BEGINNERS CONSTRUCTION A VERON JUNIOR "COMBI-KIT"

3. showing addition of crosspieces
A formers

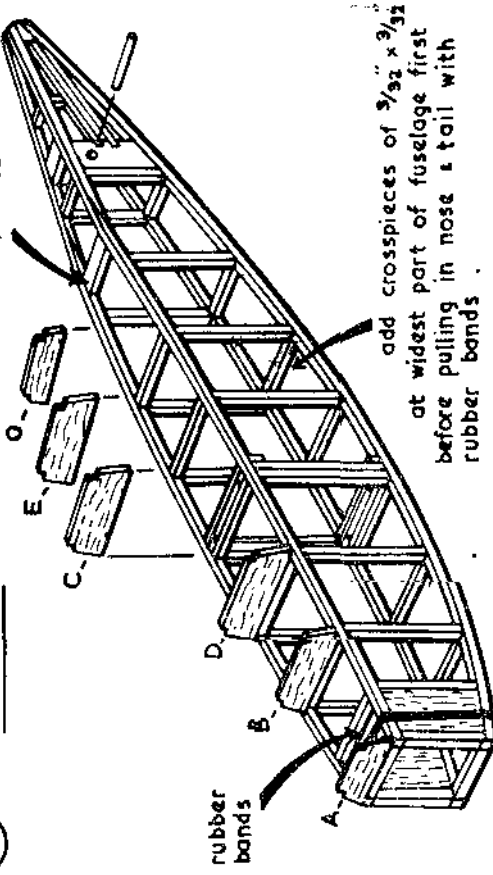

4. showing complete make-up of fuselage with formers & top stringers

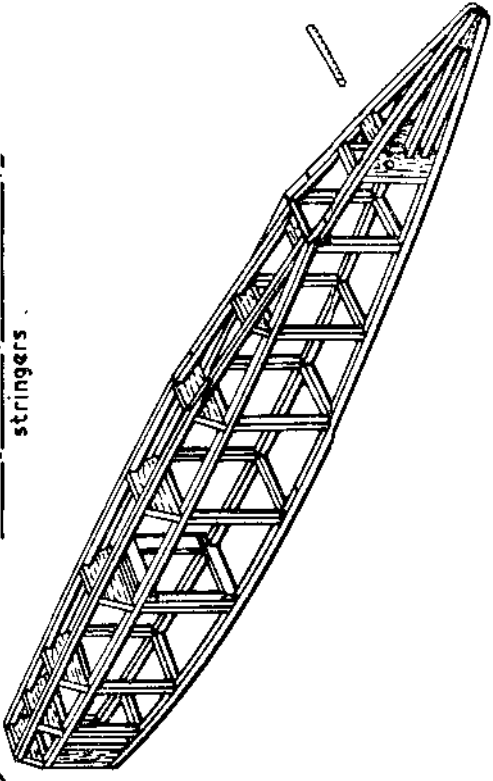

7. under-carriage and noseblock

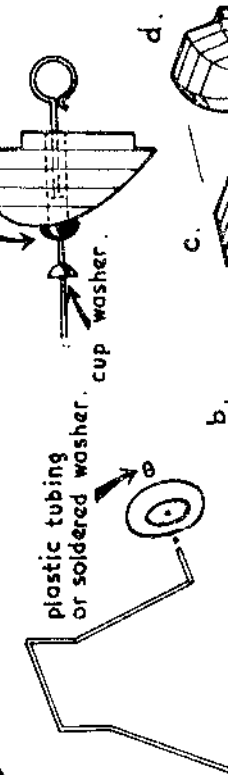

8. propeller & bush, shaft etc

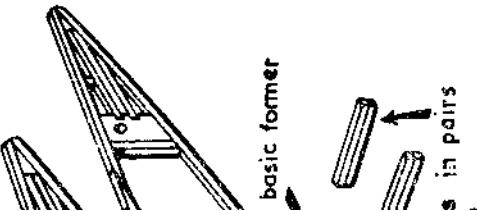

fin
on

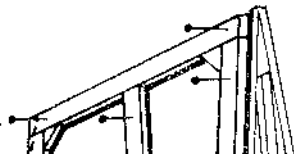

3/32"

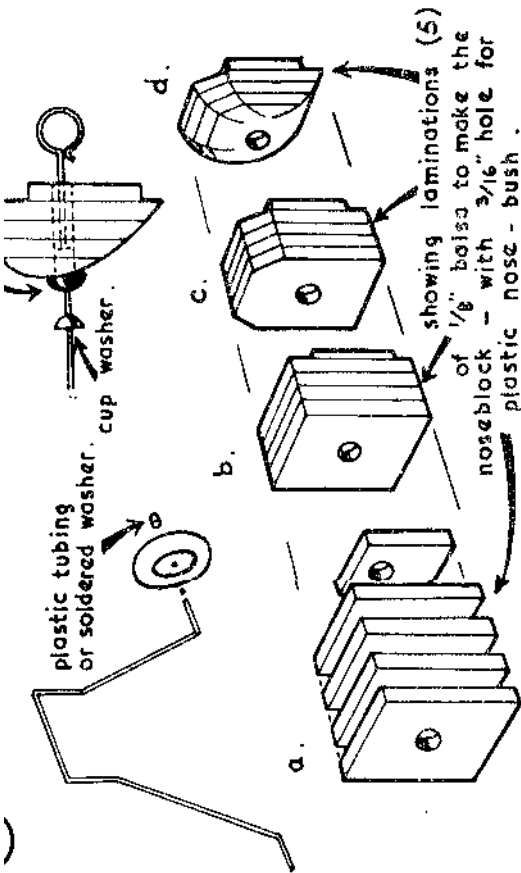

plastic tubing
or soldered washer, cup washer.

showing laminations (5)
of 1/8" balsa to make the
noseblock - with 3/16" hole for
plastic nose - bush.

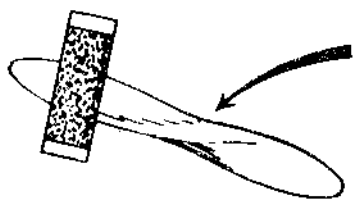

sandpaper & hardwood
block to finish propeller.

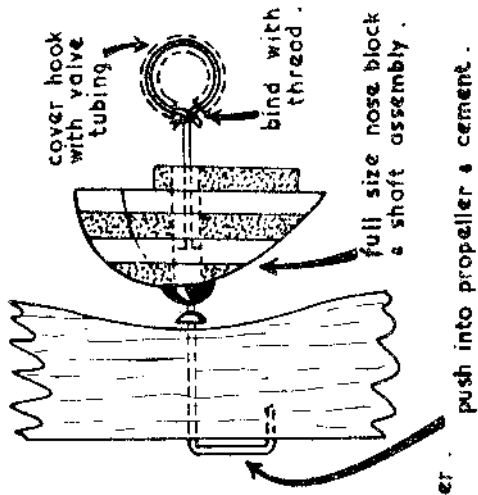

cover hook with valve tubing
bind with thread.
full size nose block & shaft assembly.
push into propeller & cement.

UILDING INSTRUCTIONS

leading edges and tips, or trailing edge. Mark it with template as in plan. Lay over plan above and coat all joints with glue. 1/8" x 1/8" set up on and paste to thin card, sanded locations, leaning it with template as in panels overnight to dry for to thickness of 1/32" to streamline.

iplane outline, pinning it and flush scarf joints 1/8" deep and inset with cement. Gussets are essential to prevent war to set perfectly hard night.

1/8" wide balsa in exactly sets at corners indicated from the board until

reamline, leading edges Do not locate on model

UNDERCARRIAGE.

Full size pattern for the 20 s.w.g. undercarriage is given on the plan. This should fit closely against the front inside edge of the verticals indicated on the plan where they are bound with thread and coated with cement. Add the scrap corner gussets as indicated for strength. See Stage 7.

NOSEBLOCK.

Make from laminated 1/8" balsa sheet supplied, cutting to templates given on plan, four large and one small — each cross-grained. Cut 3/32" holes neatly with point of sharp balsa knife, offsetting the holes slightly when laminating to give "down-thrust" to the shaft. See plan, side view, and stage 7.

Make the rear lamination a tight fit in the nose. When set, carve the nose block to contour of frame A, rounding surfaces as in side view to a streamline nose. Noseblock is not cemented in place, but made removable for stretch-winding the rubber motor and motor replacements.

PROPELLER, SHAFT AND MOTOR.

The plastic bush may be cemented into the wooden noseblock. Ensure that the hole in the bush permits free running of the 20 s.w.g. propeller shaft.

With garnet paper wrapped around a hardwood block, sand the balsa propeller smooth and check for balance. Give two coats of shrinking dope to seal the wood, sanding again between coats.

Assemble the shaft unit as shown in Stage 8, with cup washer between propeller and plastic bush. Bond the shaft back into the propeller, using pliers. Cement in firmly. Cover round hook with valve or plastic tubing.

Join ends of the 3/4" wide strip rubber supplied with double knot into a loop not more than 10% long; place on hook and close hook with two loops of knotted thread. See Stage 8. DO NOT INSERT MOTOR IN FUSELAGE UNTIL AFTER COVERING AND COMPLETION OF MODEL.

COVERING AND ASSEMBLY.

Cover the wing, tail and fin panels with pieces of tissue about 1/2" wider all round than the part to be covered. Use tissue paste as adhesive, applying only to outer edges of top and bottom surfaces, not to the ribs.

Cover the fuselage in lengthwise strips, applying tissue to longons and end verticals only. Do not incur twists in the fuselage.

Spray all parts with water, using a modeller's spray; never brush the water on. When dry, give the wings, tail and fin one coat of clear shrinking dope and the fuselage two coats. Do not use full strength dope, but add at least 25% thinner. Check all parts for warps whilst drying.

Cement the tailplane on its platform, checking for level with the fuselage; then cement the fin upright in place. View along the fuselage for vertical and alignment.

The wings are now joined, using the dihedral gusset on the cut-

out balsa sheet. Check the dihedral as given on the plan, cementing the wings firmly to the fuselage.

Trim the cockpit cellophane to fit and attach by rimming very lightly with cement. Outline the cockpit details with coloured dope or strips of coloured tissue doped on.

Add the fin fairing 'M'.

TRIMMING AND FLYING

Lubricate the rubber motor thoroughly — available in tubes from your local model shop. Feed the strands in through the nose aperture and secure the two loops at the rear with the 3/32" anchor dowel. Check that the peg is tight enough not to slip out.

The model should balance level when supported at the wing tips under the spar. If not, add plasticine to nose or tail as required. Test glide over grass in calm windless conditions. Launch forward, slightly nose down, at normal gliding speed. If the model dives, add 3/4" wide gummed paper trim tabs to trailing edge of tail and bend up slightly. If the model stalls (nose up, then dives), add tabs, but bend down slightly. Try to achieve a fine, even glide. Turns can be similarly achieved with a tab on the fin.

Wired on 50 turns to motor and launch; if satisfactory, increase turns by 50's to maximum of 350 turns. As power increases, add small pieces of balsa packing above nose bush to give "down-thrust".

When you have completed this model, ask your dealer to show you the others in the 'VERON' range of Flying Models and for our latest free illustrated folder.

Manufactured by MODEL AIRCRAFT (Bournemouth) LTD., BOURNEMOUTH, ENGLAND

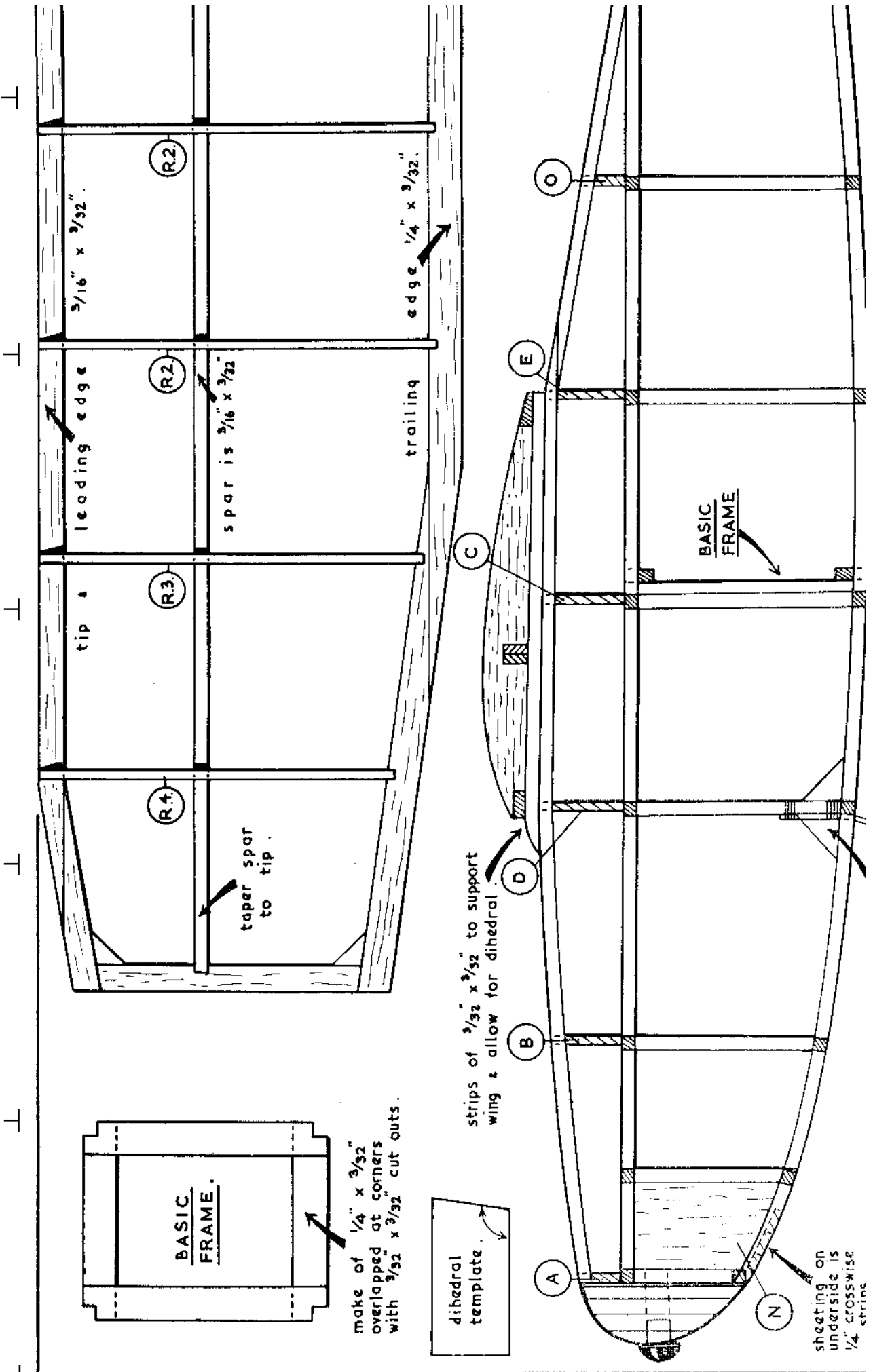

$3/16" \times 3/32"$

(R2)

leading edge

(R2)

spar is $3/16" \times 3/32"$

edge $1/4" \times 3/32"$

trailing

tip

(R3)

(R4)

taper spar to tip

BASIC FRAME

make of $1/4" \times 3/32"$ overlapped at corners with $3/32" \times 3/32"$ cut outs.

dihedral template

strips of $3/32" \times 3/32"$ to support wing & allow for dihedral

BASIC FRAME

sheeting on underside is $1/4"$ crosswise $1/4"$ string

(A)

(B)

(D)

(C)

(E)

(O)

(N)

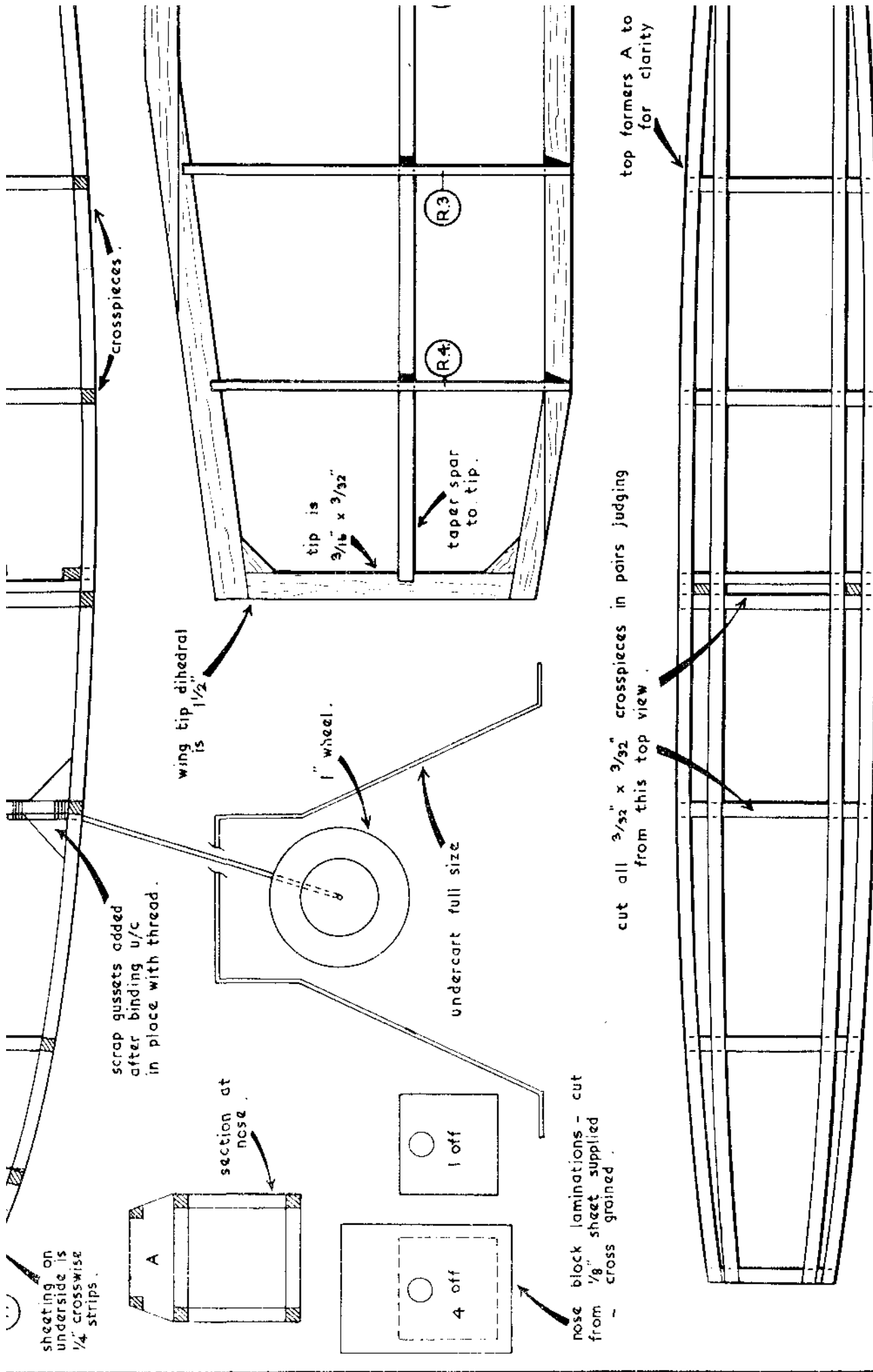



VERON

EONS L

1. make two sides directly over plan
steam longerons first.

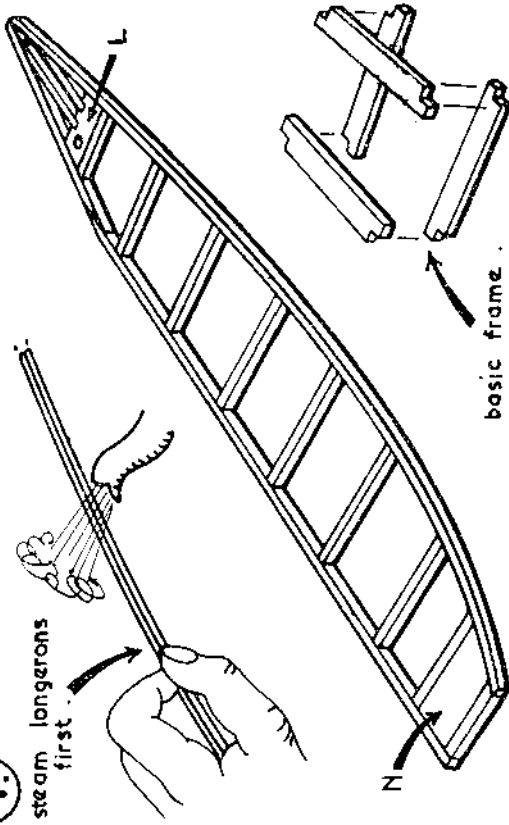

basic frame.

2. joining two fuselage halves with basic former

basic former ensures squareness of fuselage.

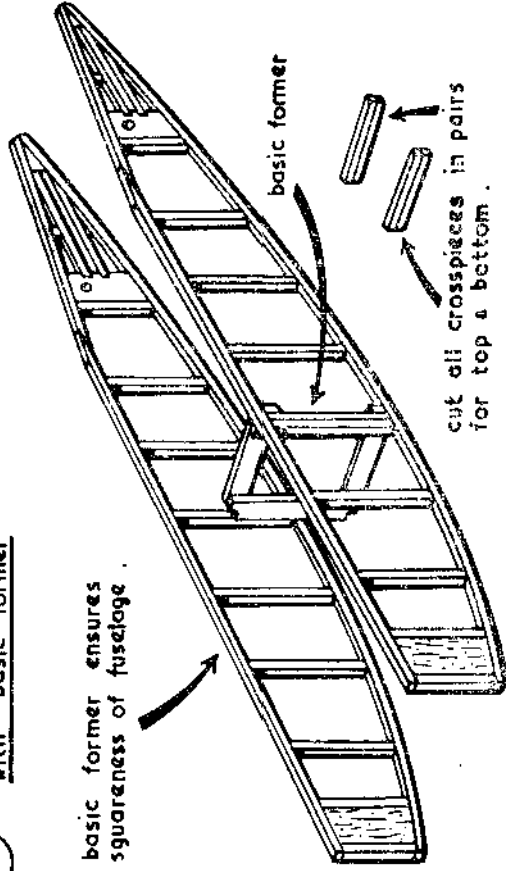

basic former

cut all crosspieces in pairs for top & bottom.

3. showing

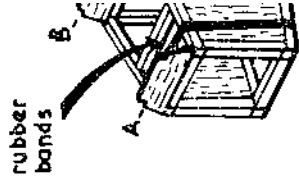

rubber bands

5. wing structure

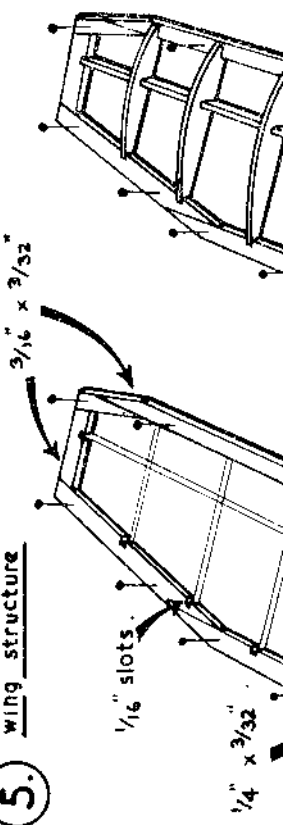

1/16" slots.

1/4" x 3/32"

6. tailplane & fin

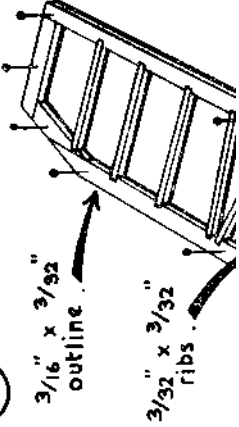

3/16" x 3/32" outline.

3/32" x 3/32" ribs.

construct tail & fin directly over plan.

7. under-c

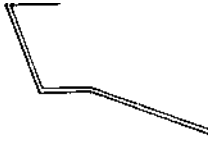

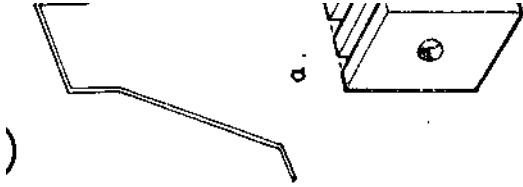

construct tail & fin directly over plan.

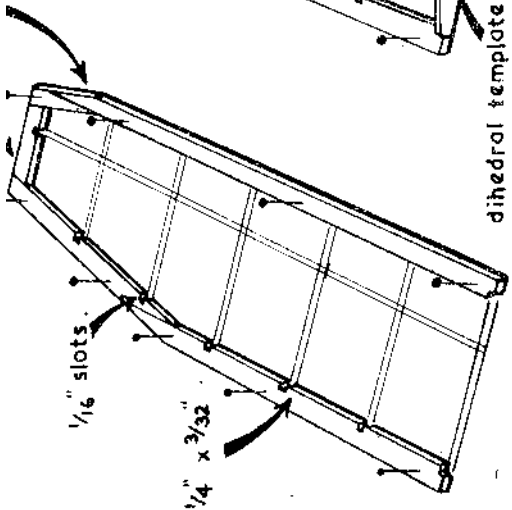
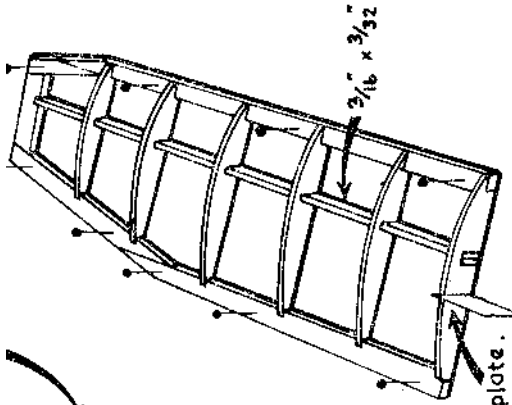
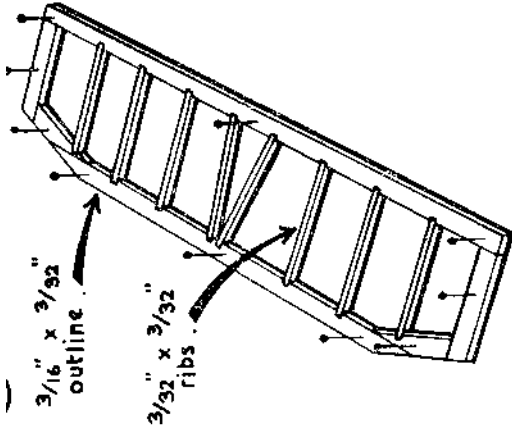

dihedral template.

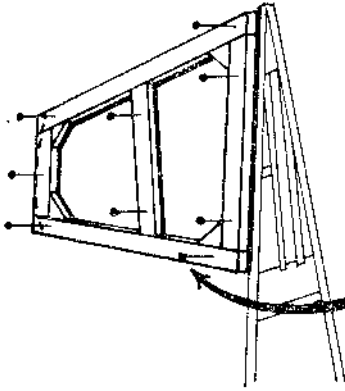

all fin members are 3/16" x 3/32"

BUILDING INSTRUCTIONS

This series of 'VERON' Sport Flying Models are the essence of simplicity and make ideal beginners' models, giving initial experience in construction and assembly. You need only 'VERON' Balsa knife, BRITEX Balsa Wood Cement, small half-inch pin or modelling pins, a pair of small round-nose or side-cutting pliers, waxed thread and fine garnet paper. A tube of BRITEX Tissue Paste, small jar of BRITEX Clear Shrinking Dope and Thinners and soft brush will complete your requirements.

Study the plan carefully and identify all the parts on the die-cut sheets of balsa. Familiarize yourself with the sequence and method of construction as detailed in the pictorial diagrams. Separate out the balsa parts as enumerated on the plan of your 'Combi-Kit'. The plan can be cut neatly in half, dividing the pictorial sequence and instructions from the plan over which the parts are built. Cover the plan with waxed or greaseproof paper and pin both to a building board.

FUSELAGE.

Select even grade $\frac{3}{32}$ " x $\frac{3}{32}$ " strips for the longerons of your basic sides. Steam to a gentle curve the lower longerons over a kettle spout. Pin in place over plan with pins either side of strips — never through the wood. Add all vertical struts of $\frac{3}{32}$ " x $\frac{3}{32}$ " ensuring good clean butt and scarf joints and double coating all grain before applying the first coat being well rubbed into the wood. Fill in the nose-bay with sheeting 'N', and trim the rear dowl anchor brace 'L' to fit neatly between longerons. Cut out the hole and ream circular with the end of the dowl. Coat the edges of the hole with cement to strengthen the wood fibres; do not let the dowl remain in place whilst drying.

Allow to set perfectly hard before removing from board, then construct second identical side using, where possible, the same pin holes. However, remember that nose-sheeting 'N' and rear dowl anchor base 'L', being $\frac{1}{16}$ " sheet, are set flush with opposite edge to first side. See Stage 1.

Construct the basic form of $\frac{1}{16}$ " x $\frac{3}{32}$ " strips with corners overlapped and notched out $\frac{3}{32}$ " x $\frac{3}{32}$ " to fit longerons. Allow to set before removing from the board.

Join the two fuselage halves with the basic former where indicated, cementing the uprights of the brace against the uprights of the fuselage. This former will securely square the two fuselage sides. Draw the rear webs together and cement, securing with clothes pegs until dry. Cut all $\frac{3}{32}$ " x $\frac{3}{32}$ " crosspieces in pairs and insert across fuselage at widest part first, ensuring accurate joints, top and bottom together. Draw fuselage front together with rubber bands to secure whilst adding crosspieces. View fuselage from front to check for twists. See Stages 2 and 3.

Now add formers to top of fuselage where indicated. Very lightly steam upper stringers before trimming to length and adding to top formers. When set, sand very lightly to contour of formers, especially at nose. See Stage 4.

Fill in underside of nose-bay with strips of $\frac{1}{16}$ " x $\frac{3}{32}$ " set cross-wise and sanded to curvature.

Check length of $\frac{3}{32}$ " dowl through holes in rear anchor braces 'L' for tight fit. This is not cemented in place, but left removable to permit replacement of rubber motors. Wrap fine garnet paper around a flat wooden block and carefully sand away any unevenness of the structure.

WINGS.

Trim to length strips of $\frac{3}{32}$ " x $\frac{3}{32}$ " for leading edges and tips, also trim and join lengths of $\frac{1}{16}$ " x $\frac{3}{32}$ " for trailing edge. Mark and cut out accurately the $\frac{1}{16}$ " slots for ribs. Lay over plan above waxed tissue and pin outline in place, double coating all joints with cement. Notch the tip to take the spar of $\frac{1}{16}$ " x $\frac{3}{32}$ " set up on edge with pins either side.

Cut out dihedral template given on plan and paste to thin card. Now set up all ribs in their correct numbered locations, leaning the base rib to allow for dihedral, setting it with template as in Stage 5. Whenever possible, leave wing panels overnight to dry before removing from board. Taper spar to thickness of $\frac{3}{32}$ " tip piece outside rib R.4. Sand all edges to streamline.

TAILPLANE AND FIN.

Trim strips $\frac{3}{32}$ " x $\frac{3}{32}$ " to length for tailplane outline, pinning in place over plan, making perfectly neat and flush scarf joints where indicated. Notch out the $\frac{3}{32}$ " slots $\frac{1}{16}$ " deep and inset the ribs of $\frac{3}{32}$ " x $\frac{3}{32}$ ", double coating all joints with cement. Gosses cut diagonally from scrap $\frac{3}{32}$ " wide strips are essential to prevent warps at all corners where indicated. Allow to set perfectly hard before removing from board, preferably overnight.

The fin is constructed of flat strips of $\frac{3}{32}$ " wide balsa in exactly the same way as the tailplane. Scrap gosses at corners indicated are essential for rigidity; do not remove from the board until quite set. See Stage 6.

Sand the edges of tailplane and fin to streamline, leading edges and tips round, and trailing edges to taper. Do not locate on model until after covering.

UNDERCARRIAGE.

Full size pattern in plan. This should be verticals indicated and coated with cement for strength. See Stage 5.

NOSEBLOCK.

Make from lamin plates given on plan. Cut $\frac{3}{32}$ " holes nearly holes slightly when shaft. See plan, six

Make the rear la carve the nose block in side view to a st place, but make rer and motor replacem

PROPELLER, SHAFT.

The plastic bush: Ensure that the ho 20 s.w.g. propeller

With garnet paper balsa propeller smoc shrinking dope to se